

**Modbus®**

DCT 531

Industrial Pressure Transmitter with RS485 Modbus RTU

Stainless Steel Sensor

accuracy according to IEC 60770:
standard: 0.25 % FSO
option: 0.1 % FSO

Nominal pressure

from 0 ... 100 mbar up to 0 ... 400 bar

Output signal

RS485 with Modbus RTU protocol

Special characteristic

- ▶ pressure value
- ▶ perfect thermal behaviour
- ▶ excellent long term stability
- ▶ reset function

Optional versions

- ▶ pressure port
G 1/2" flush up to max. 40 bar
- ▶ pressure sensor welded
- ▶ customer specific versions

The **DCT 531** with RS485 interface uses the communication protocol Modbus RTU which has found the way in industrial communication as an open protocol. The Modbus protocol is based on a master slave architecture with which up to 247 slaves can be questioned by a master.

Due to the usage of high quality materials and components, the **DCT 531** is suitable for almost every industrial application, if the medium is compatible with stainless steel 316L.

The modular concept of the device allows customized mechanical connections, so it is easy to adapt the pressure transmitter to different conditions on-site.

Preferred areas of use are



Plant and machine engineering



Energy industry

**Modbus®**

Input pressure range												
Nominal pressure gauge	[bar]	-1...0	0.10	0.16	0.25	0.40	0.60	1	1.6	2.5	4	6
Nominal pressure absolute	[bar]	-	-	-	-	0.40	0.60	1	1.6	2.5	4	6
Overpressure	[bar]	5	0.5	1	1	2	5	5	10	10	20	40
Burst pressure \geq	[bar]	7.5	1.5	1.5	1.5	3	7.5	7.5	15	15	25	50
Nominal pressure gauge / absolute	[bar]	10	16	25	40	60	100	160	250	400		
Overpressure	[bar]	40	80	80	105	210	600	600	1000	1000		
Burst pressure \geq	[bar]	50	120	120	210	420	1000	1000	1250	1250		
Vacuum resistance		$p_N \geq 1$ bar: unlimited vacuum resistance					$p_N < 1$ bar: on request					
Output signal												
Digital		RS 485 with Modbus RTU protocol (pressure)										
Supply												
Direct current		$V_S = 9 \dots 32 V_{DC}$										
Performance												
Accuracy ¹		standard: $\leq \pm 0.25$ % FSO option: $\leq \pm 0.10$ % FSO										
Long term stability		$\leq \pm 0.1$ % FSO / year at reference conditions										
Measuring rate		500 Hz										
Delay time		500 msec										
¹ accuracy according to IEC 60770 – limit point adjustment (non-linearity, hysteresis, repeatability)												
Thermal effects (offset and span)												
Tolerance band		$\leq \pm 0.75$ % FSO										
In compensated range		-20 ... 85 °C										
Permissible temperatures												
Medium		-40 ... 125 °C										
Electronics / environment		-40 ... 85 °C										
Storage		-40 ... 100 °C										
Electrical protection												
Short-circuit protection		permanent										
Reverse polarity protection		on supply connection no damage, but also no function										
Electromagnetic compatibility		emission and immunity according to EN 61326										
Mechanical stability												
Vibration		10 g RMS (25 ... 2000 Hz)					according to DIN EN 60068-2-6					
Shock		100 g / 11 msec					according to DIN EN 60068-2-27					
Materials												
Pressure port / housing		stainless steel 1.4404 (316 L)										
Seals		standard: FKM option: EPDM; welded version ² (for $p_N \leq 40$ bar)										others on request
Diaphragm		stainless steel 1.4435 (316 L)										
Media wetted parts		pressure port, seal, diaphragm										
² welded version only with pressure ports according to EN 837, $p_N \leq 40$ bar												
Miscellaneous												
Weight		approx. 210 g										
Ingress protection		IP 67										
Current consumption		max. 10 mA										
Operational life		100 million load cycles										
Installation position		any ³										
CE-conformity		EMC Directive: 2014/30/EU					Pressure Equipment Directive: 2014/68/EU (module A) ⁴					
³ Pressure transmitters are calibrated in a vertical position with the pressure connection down. If this position is changed on installation there can be slight deviations in the zero point for pressure ranges $p_N \leq 1$ bar.												
⁴ This directive is only valid for devices with maximum permissible overpressure > 200 bar												

Wiring diagram

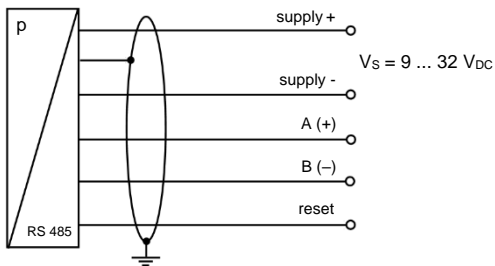

Pin configuration / electrical connection

Electrical connection	M12x1, metal (5-pin)
Supply +	1
Supply -	3
A (+)	2
B (-)	4
Reset	5
Shield	plug housing

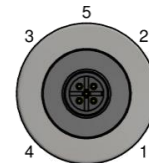

Dimensions (mm / in)

standard

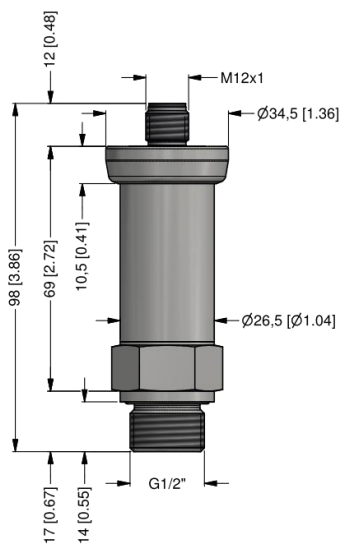

G1/2" DIN 3852 with M12x1

options

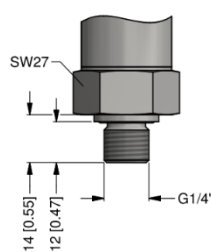

G1/4" DIN 3852

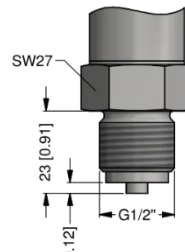

G1/2" EN 837

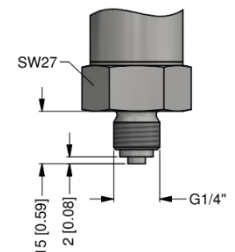

G1/4" EN 837

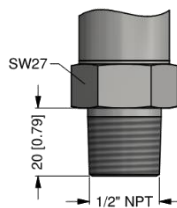

1/2" NPT

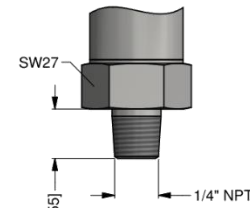

1/4" NPT

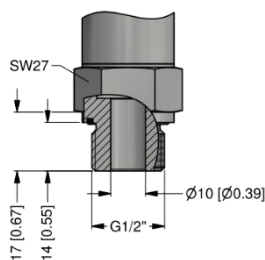

G1/2" DIN 3852 open port ($p_N \leq 40$ bar)

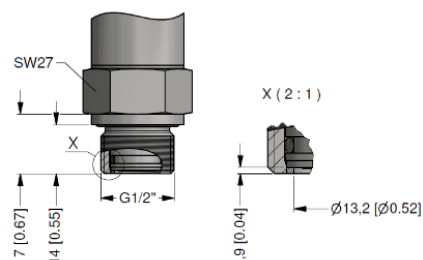

G1/2" DIN 3852 with semi-flush sensor ($p_N \leq 40$ bar)

⇒ metric threads and other versions on request

DCT 531

Industrial Pressure Transmitter with RS485 Modbus RTU

Technical Data

Configuration Modbus RTU					
Standard configuration	001	-	1	-	1
Address					
Address	001				
	...				
	247				
Baud Rate					
4800 Bd			0		
9600 Bd			1		
19200 Bd			2		
38400 Bd			3		
Parity					
None					0
Odd					1
Even					2
Configuration code (to specify with order)		-		-	

© 2020 DRUCK & TEMPERATUR Leitenberger GmbH – The specifications given in this document represent the state of engineering at the time of publishing. We reserve the right to make modifications to the specifications and materials.

